

**Questions, problems, need help?**  
Call our customer service department at  
1-866-839-2888, 8 a.m. - 5 p.m., EST, Monday - Friday

# PACKAGE CONTENT

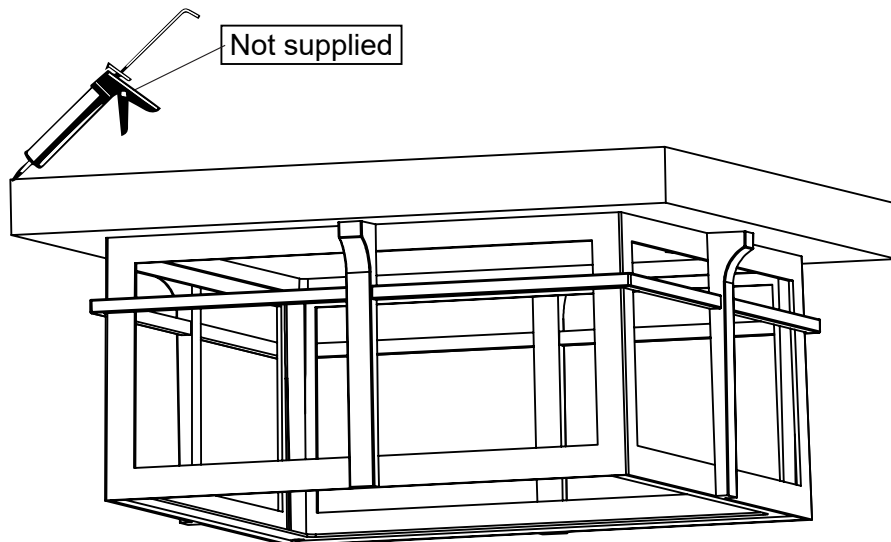
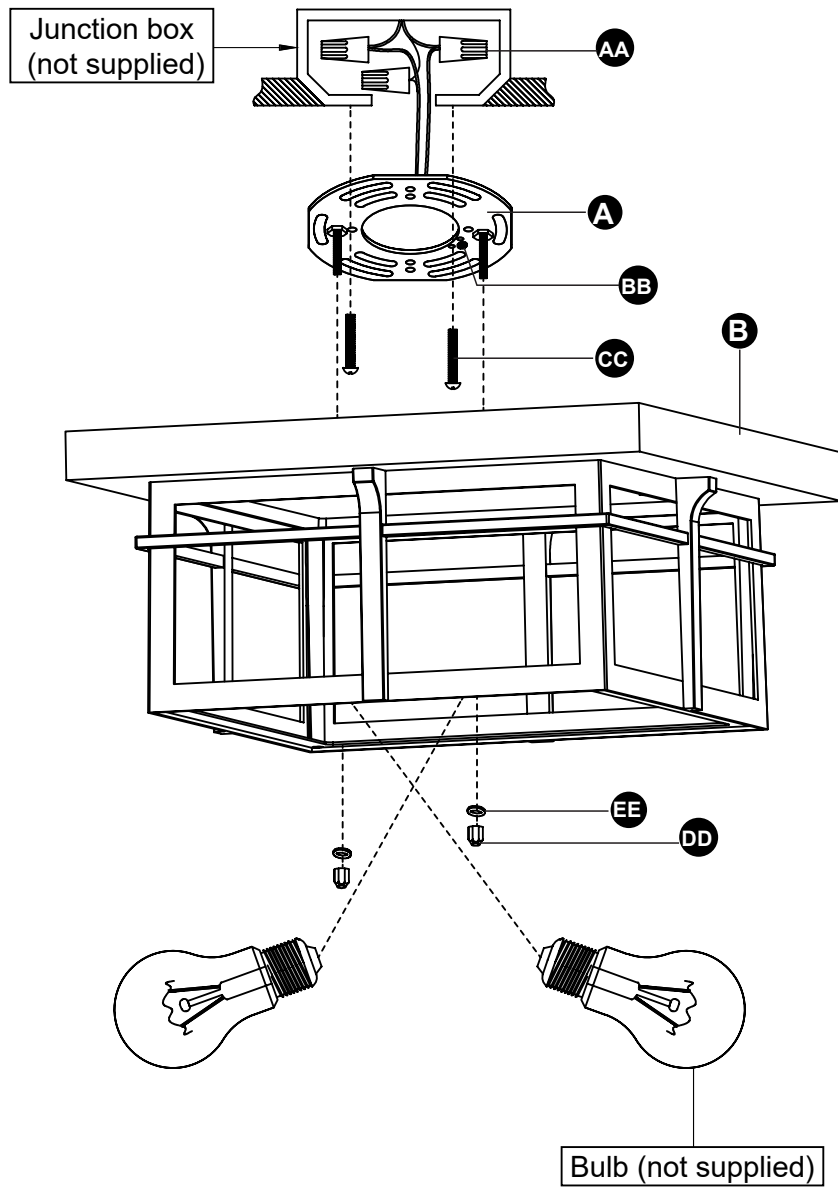

## PART LIST

PART #	DESCRIPTION	QUANTITY	REPLACEMENT PART AVAILABILITY
A	Mounting Plate	1	
B	Fixture Canopy	1	
AA	Twist-cap Connector	3	
BB	Grounding Bolt #5x5 mm	1	
CC	Bolt #8x25 mm	2	
DD	Cap Nut	2	
EE	Washer	2	

## TOOLS REQUIRED (not supplied)

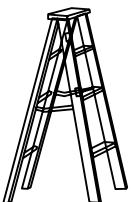

Ladder

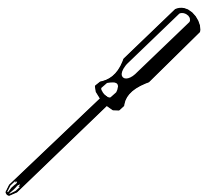

Phillip Screwdriver



Slotted Screwdriver

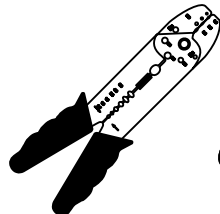

Wire stripper

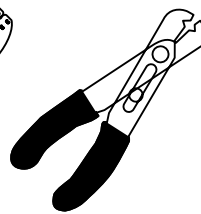

Wire cutter



Safety goggles

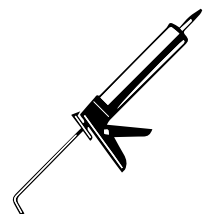

Silicone



## SAFETY INFORMATION



### CAUTION

Please carefully read the following important safety information before handling or installing this light. There is a risk of serious injury while handling this product. To minimize these risks, please note:

- Before starting the installation of this fixture or the removal of a previous fixture, disconnect the power by turning off the circuit breaker or by removing the fuse at the fuse box.
- Be careful not to damage or cut the wire insulation (covering) during fixture installation. Do not permit wires to contact any surface having a sharp edge. To do so may damage or cut the wire insulation, which could cause serious injury or death from electric shock.
- Do not mount or place near gas or electric heaters, fireplace, candles or other similar sources of heat.
- If you have any doubts or questions about the installation of this fixture, consult a qualified electrician.
- Do not cover the product with cloth, paper or any material not part of the product when in use.
- Read and follow all instructions that are on the product or provided with the product.
- Before beginning assembly of product, make sure all parts are present. Compare parts with package contents list and hardware contents list. If any part is missing or damaged, do not attempt to assemble the product.
- Keep this installation manual for future reference.



## SAFETY NOTICE



### NOTICE

Any modification or alteration from what is specified in this instruction manual will void any and all warranty on this product.

PATRIOT LIGHTING® is not responsible for any damage to the unit or personal property caused by improper installation. If you disregard instructional warnings, you will void your warranty and possibly deal with damage.

## PREPARATION

Before beginning assembly, installation or operation of product, make sure all parts are present. Compare parts with package contents list and diagram on previous page. If any part is missing or damaged, do not attempt to assemble, install or operate the product. Contact customer service for further assistance at 1-866-839-2888, 8am – 5pm EST, Monday-Friday.

# INSTALLATION

1.1. Uninstall mounting plate (A) by rotating cap nuts (DD) counterclockwise. Pass all wires through mounting plate (A). Connect the green (ground) wire from the fixture to the green (ground) wire on the mounting plate. Connect the fixture neutral (white) wire to house neutral (white) wire and the fixture black (live) wire to the house black (live) wire. Use provided twist cap connectors (AA) to make all connections.

1.2. Install the mounting plate (A) to your junction box with the bolts (CC).

1.3. Install the fixture canopy (B) to the mounting plate (A) by inserting the bolts through the mounting plate (A) and fixture canopy (B), then use the washers (EE) and cap nuts (DD) to tighten the fixture canopy (B). Ensure that cap nuts (DD) are securely tightened.

1.4. Carefully install the bulbs (not supplied) into the socket (base bulb is E26, and maximum bulb wattage is 60W).

1.5. Apply a clear silicone water sealant (not supplied) around the outside perimeter of the fixture canopy (B).

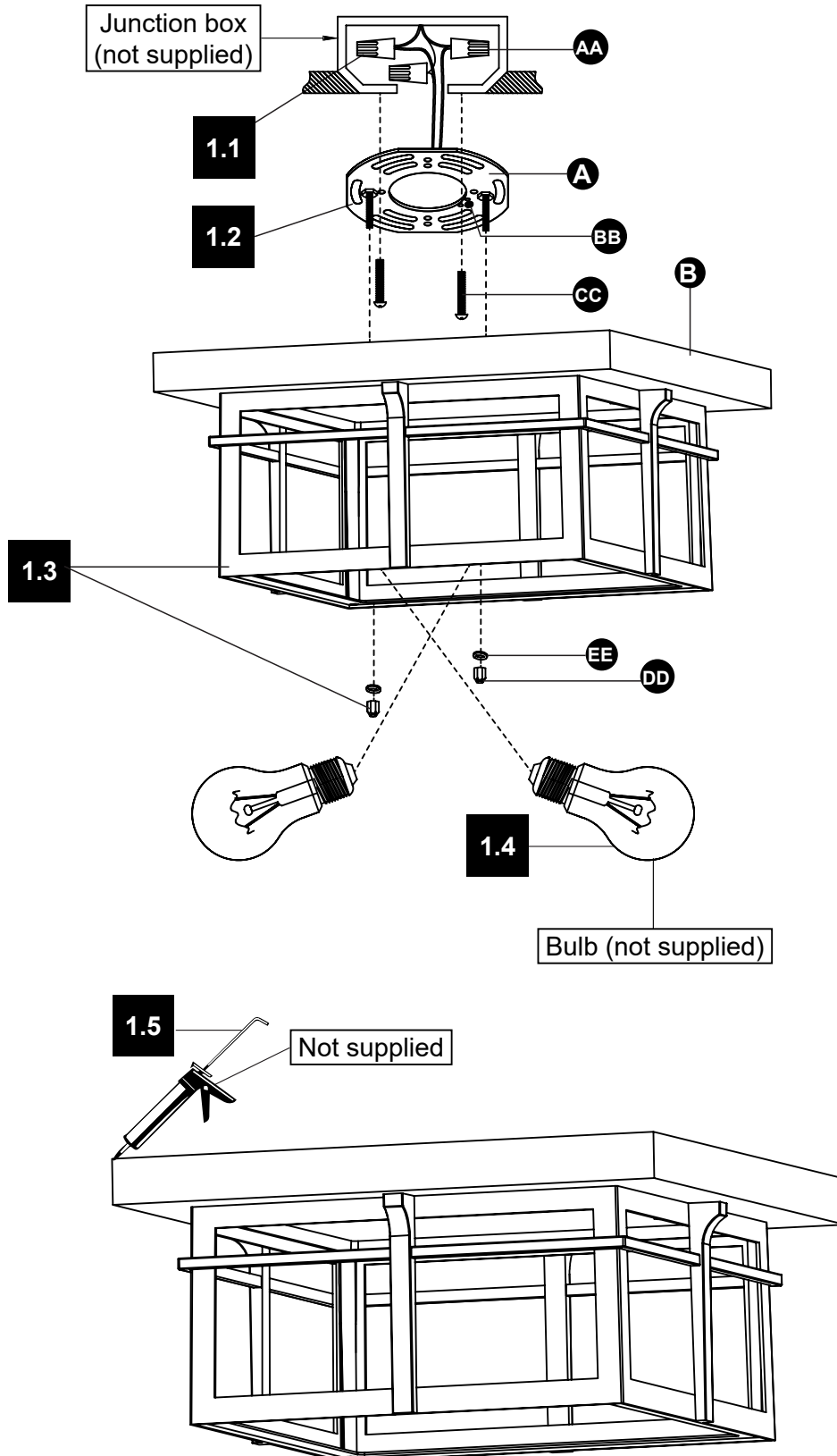

## MAINTENANCE AND CARE

Patriot Lighting products will remain beautiful for many years if you properly care for them.

Patriot Lighting does not recommend the use of harsh abrasive cleansers on any of its products. Harsh cleansers will damage the finish of your product.

To Replace Bulb:

1. Disconnect the power by turning off the circuit breaker or by removing the fuse at the fuse box.
2. Carefully unscrew the bulb from the socket counterclockwise.
3. Replace with new bulb and securely install into the socket by rotating clockwise.

This fixture requires a E26 base bulb. Maximum bulb wattage is 60W.

To clean the light fixture, disconnect the power by turning off the circuit breaker or by removing the fuse at the fuse box and wipe the light fixture with a damp, non-abrasive cloth. Gentle reminder, do not use harsh or abrasive cleaners as it will damage the finish of your product.

**FIVE-YEAR LIMITED WARRANTY:** If, during normal use, this PATRIOT LIGHTING<sup>®</sup> lighting fixture breaks or fails due to a defect in material and workmanship within five (5) years from the date of original purchase, simply bring this lighting fixture with the original sales receipt back to your nearest MENARDS<sup>®</sup> retail store. At its discretion, PATRIOT LIGHTING<sup>®</sup> agrees to have the product or any defective part(s) repaired or replaced with the same or similar PATRIOT LIGHTING<sup>®</sup> product or part free of charge, within the stated warranty period, when returned by the original purchaser with original sales receipt. This warranty; (1) excludes expendable parts including but not limited to light bulbs; (2) does not cover damage that has resulted from abuse or misuse; and (3) does not cover any losses, labor, injuries to persons/property or costs, This warranty does give you specific legal rights and you may have other rights, which vary from state to state.