



1 Piece patio set / Ensemble de patio de 1 pièce / Juego de patio de 1 pieza

Assembly Instructions
Instructions d'assemblage
Instrucciones de ensamble

**IMPORTANT, RETAIN FOR FUTURE REFERENCE:
READ CAREFULLY**

IMPORTANT : À LIRE ATTENTIVEMENT ET À CONSERVER

**IMPORTANTE, GUARDE PARA FUTURAS REFERENCIAS:
LEA DETENIDAMENTE**

HEAD OFFICE / SIÈGE SOCIAL / OFICINA PRINCIPAL
2800, rue Étienne-Lenoir, Laval
Québec H7R 0A3 Canada

This item is intended for outdoor domestic use only. Not for commercial use.
Cet article est destiné à un usage domestique extérieur uniquement. Non conçu pour une utilisation commerciale.
Este artículo es para uso doméstico en exteriores solamente. No es para uso comercial.

Questions, problems, missing parts?

Before returning to your retailer, call our customer service department at

1-866-839-2888

8 a.m. - 5 p.m., EST, Monday - Friday
(Canada and United States only)

English and French speaking representatives available

Questions, problèmes ou pièces manquantes?

Avant de retourner le produit à votre détaillant, communiquer avec le service à la clientèle au

1-866-839-2888

du lundi au vendredi de 8 h à 17 h HE
(Canada et États-Unis)

Langues : anglais et français

Preguntas, problemas, piezas faltantes?

Antes de volver a la tienda, llame a nuestro departamento de servicio al cliente al





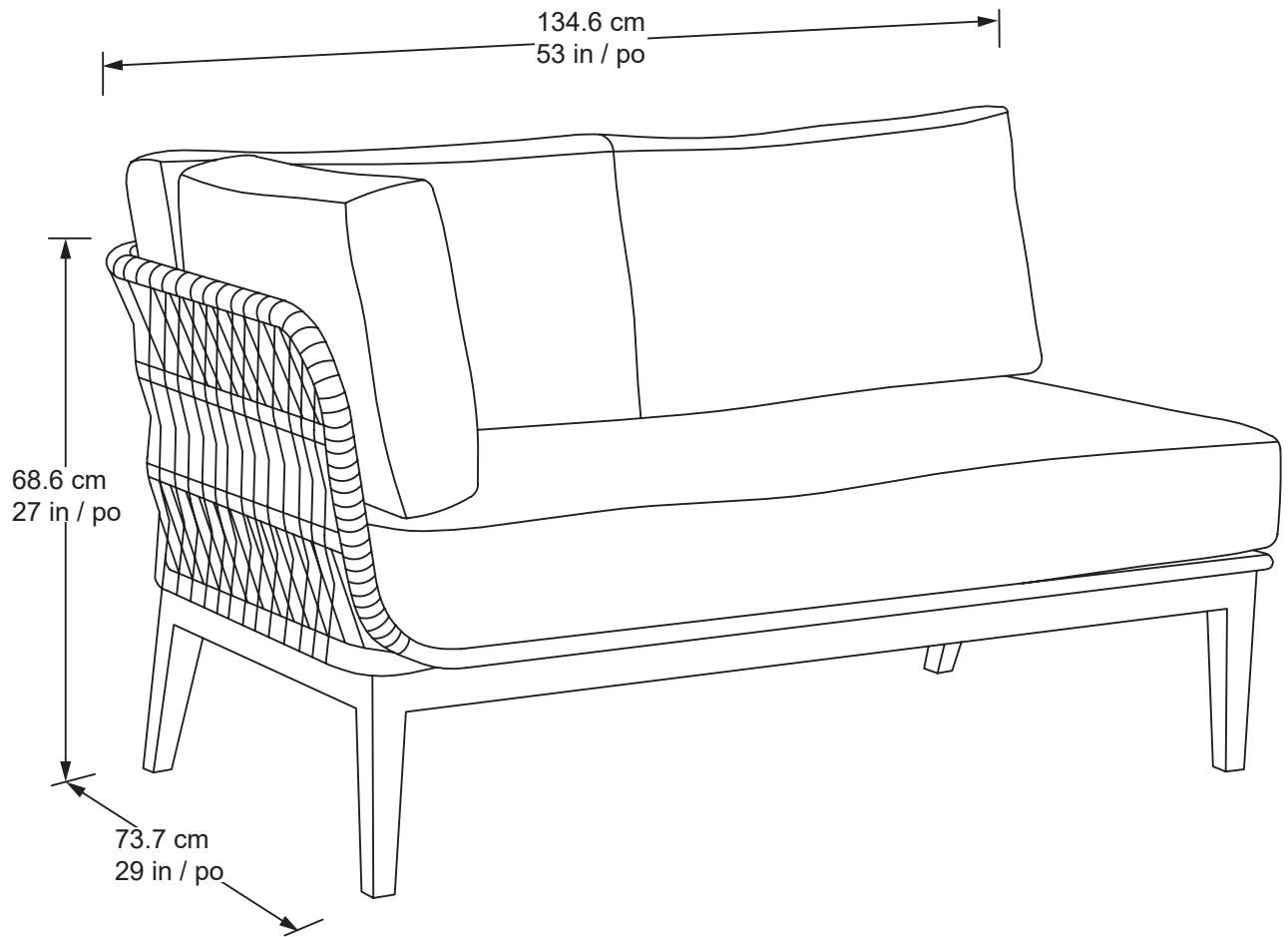

1-866-839-2888

8 am. - 5 pm., HDE, Lunes a Viernes
(Canadá y Estados Unidos solamente)

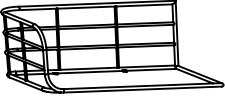
Representantes disponibles para inglés y francés

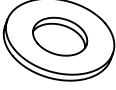

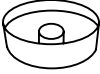
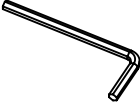
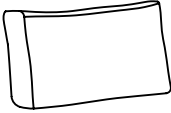
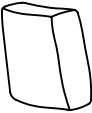

	Item / Ítem	QTY QTÉ CTD		Item / Ítem	QTY QTÉ CTD		Item / Ítem	QTY QTÉ CTD
A		1	B		1	C		
D		1	E		8	F		
G		1	H		8	I		8
								





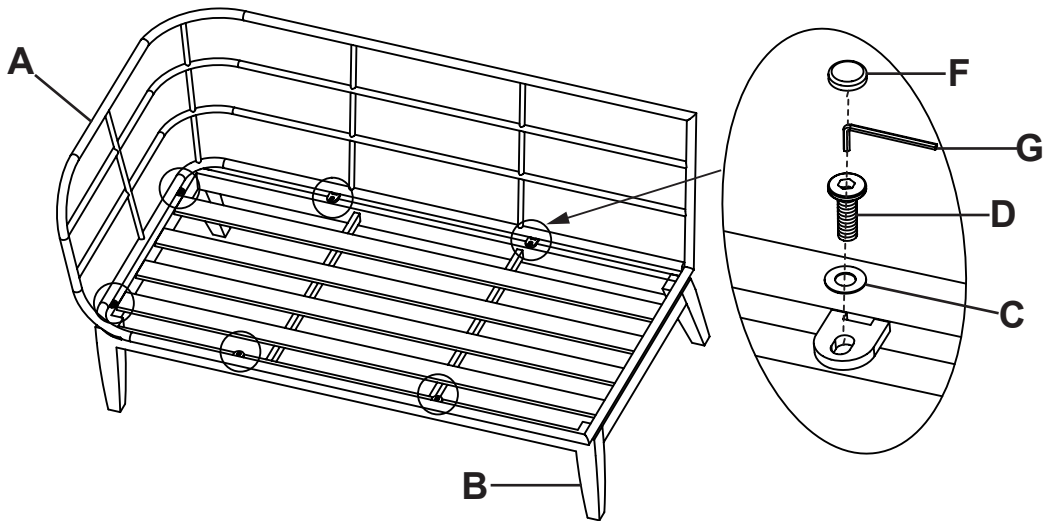

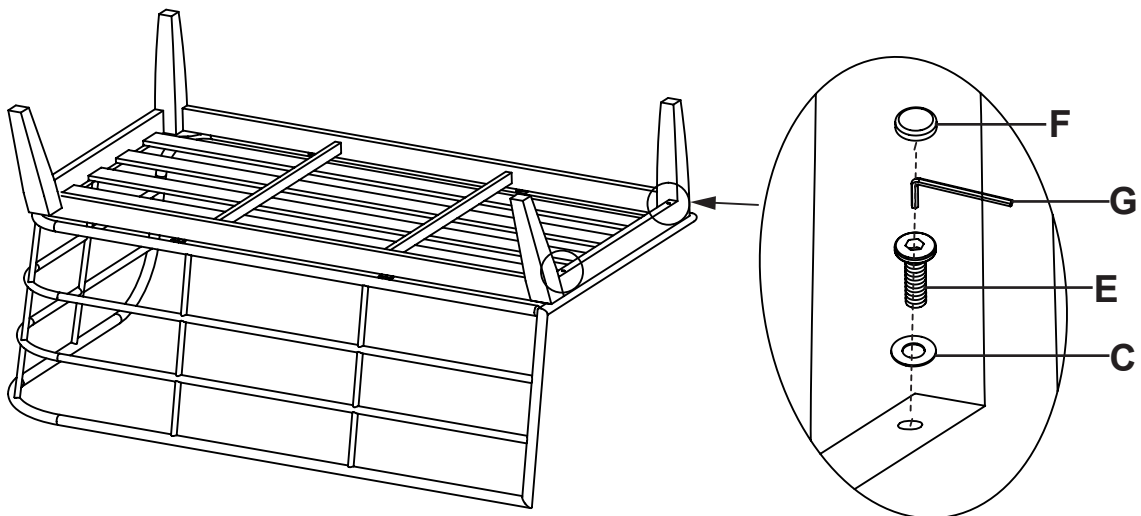

ASSEMBLY / ASSEMBLAGE / ENSEMBLE

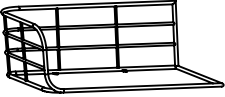
1

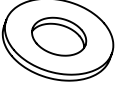

2

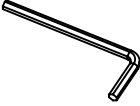
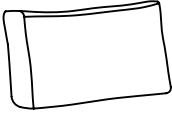

	Item / Ítem	QTY QTÉ CTD		Item / Ítem	QTY QTÉ CTD		Item / Ítem	QTY QTÉ CTD
A		1	B		1	C		
D	 M6X20	1	E	 M6X65	8	F		
G		1	H		8	I		8
								

ASSEMBLY / ASSEMBLAGE / ENSAMBLE

1

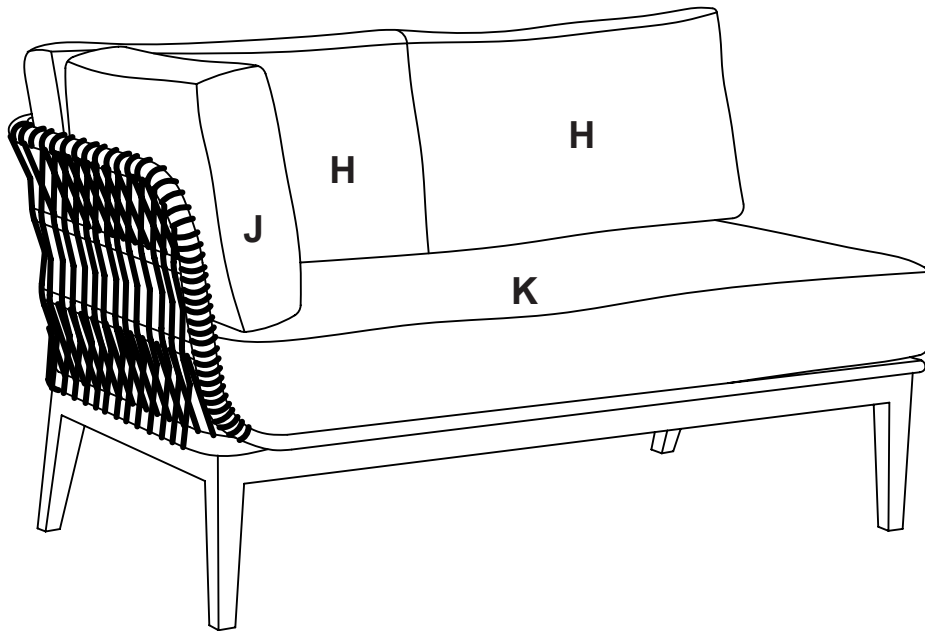

FOR DOMESTIC USE ONLY.

MAINTENANCE - Store in a dry area out of the elements, or cover with furniture covers when not in use.

CUSHIONS: CLEANING - Wipe up minor spills with a mild soap and damp cloth.

SUNBRELLA® FABRIC: CLEANING -

Sunbrella fabric should be cleaned regularly. Brush off any loose dirt and wash with a mild soap and lukewarm water solution. For stubborn stains and mildew, wash with a solution of 236 mL (1 cup) of bleach and 59 mL (1/4 cup) of mild soap per 3.8 L (gallon) of water. Rinse thoroughly to remove soap. Allow fabric to air dry.

POUR USAGE DOMESTIQUE SEULEMENT.

ENTRETIEN - Entreposer dans un endroit sec à l'abri des éléments ou couvrir à l'aide d'une housse lorsque le produit n'est pas utilisé.

COUSSINS : NETTOYAGE - Essuyez les dégâts mineurs à l'aide d'un linge humide et d'un savon doux.

TISSU SUNBRELLA^{MD} : NETTOYAGE - Le tissu Sunbrella doit être nettoyé régulièrement. Brossez le tissu pour retirer la poussière et le laver avec une solution d'eau tiède et de savon doux. Pour les taches tenaces et la moisissure, utiliser une solution composée de 236 ml (1 tasse) d'eau de Javel et de 59 ml (1/4 tasse) de savon doux pour 3,8 l (1 gal) d'eau. Rincer abondamment pour retirer le savon. Laisser sécher à l'air.

SÓLO PARA USO DOMÉSTICO.

MANTENIMIENTO - Guarde en un lugar seco alejado de la intemperie, o cúbralo con fundas protectoras para muebles cuando no está en uso.

COJINES: LIMPIEZA - Haga las limpiezas menores con un paño húmedo y un jabón suave.

SUNBRELLA® TEXTILES: LIMPIEZA -

La tela Sunbrella debe limpiarse periódicamente. Quite todo el polvo suelto con un cepillo y lave con una solución de jabón suave y agua tibia. Para manchas más difíciles y moho, lave con una solución de 236 ml (1 taza) de blanqueador y 59 ml (1/4 de taza) de jabón suave por cada 3.8 l (1 galón) de agua. Enjuague bien para eliminar el jabón. Deje que la tela se seque al aire.

To ensure longevity of your patio set each seat cushion is made with high density foam. With initial use the seat cushions may feel firm, but with continued use the cushions will continue to soften and provide the ultimate comfort for seasons to come.

Pour assurer la longévité de votre ensemble de patio, chaque coussin de siège est fabriqué en mousse haute densité. Lors de la première utilisation, les coussins de siège peuvent sembler fermes, mais avec une utilisation continue, les coussins continueront à s'assouplir et à offrir un confort ultime pour les saisons à venir.

Para asegurar la longevidad de su juego de patio, cada cojín de asiento está hecho con espuma de alta densidad. Con el uso inicial los cojines del asiento pueden sentirse firmes, pero con el uso continuado los cojines seguirán suavizándose y proporcionando la máxima comodidad para las próximas temporadas.

Distributed by:
Costco Wholesale Corporation
P.O. Box 34535
Seattle, WA 98124-1535
USA
1-800-774-2678
www.costco.com

Costco Wholesale Canada Ltd.*
415 W. Hunt Club Road
Ottawa, Ontario
K2E 1C5, Canada
1-800-463-3783
www.costco.ca

* faisant affaire au Québec sous
le nom les Entrepôts Costco

Importado por:
Importadora Primex S.A. de C.V.
Blvd. Magnocentro No. 4
San Fernando La Herradura
Huixquilucan, Estado de México
C.P. 52765
RFC: IPR-930907-S70
(55)-5246-5500
www.costco.com.mx

Costco Wholesale UK Ltd /
Costco Online UK Ltd
Hartspring Lane
Watford, Herts
WD25 8JS
United Kingdom
01923 213113
www.costco.co.uk

Costco Wholesale Spain S.L.U.
Polígono Empresarial Los Gavilanes
C/ Agustín de Betancourt, 17
28906 Getafe (Madrid) España
NIF: B86509460
900 111 155
www.costco.es

Costco Wholesale Australia Pty Ltd
17-21 Parramatta Road
Lidcombe NSW 2141
Australia
www.costco.com.au

Costco Wholesale Korea, Ltd.
40, Iljik-ro
Gwangmyeong-si
Gyeonggi-do, 14347, Korea
1899-9900
www.costco.co.kr

Costco Wholesale Japan Ltd.
3-1-4 Ikegami-Shincho
Kawasaki-ku, Kawasaki-shi,
Kanagawa 210-0832 Japan
0570-032600
www.costco.co.jp

Costco Wholesale New Zealand Limited
2 Gunton Drive
Westgate
Auckland 0814
New Zealand

Costco France
1 avenue de Bréhat
91140 Villebon-sur-Yvette
France
01 80 45 01 10
www.costco.fr

Costco Wholesale Iceland ehf.
Kauptún 3-7, 210 Gardabaer
Iceland
www.costco.is

Shanghai Minhang Costco Trading Co., Ltd
No. 235, ZhuJian Road
Minhang District, Shanghai
China 201106
+86-21-6257-7065

MADE IN CHINA / FABRIQUÉ EN CHINE / HECHO EN CHINA