



5 Pieces patio set / Ensemble de patio de 5 pièces / Juego de comedor de patio de 5 piezas

Assembly Instructions
Instructions d'assemblage
Instrucciones de ensamble

**IMPORTANT, RETAIN FOR FUTURE REFERENCE:
READ CAREFULLY**

**IMPORTANT, CONSERVER POUR CONSULTATION FUTURE :
LIRE AVEC ATTENTION**

**IMPORTANTE, GUARDE PARA FUTURAS REFERENCIAS:
LEA DETENIDAMENTE**

HEAD OFFICE / SIÈGE SOCIAL / OFICINA PRINCIPAL
2800, rue Étienne-Lenoir, Laval
Québec H7R 0A3 Canada

This item is intended for outdoor domestic use only. Not for commercial use.
Cet article est destiné à un usage domestique extérieur uniquement. Non conçu pour une utilisation commerciale.
Este artículo es para uso doméstico en exteriores solamente. No es para uso comercial.

Questions, problems, missing parts?

Before returning to your retailer, call our customer service department at

1-866-839-2888

8 a.m. - 5 p.m., EST, Monday - Friday
(Canada and United States only)

English and French speaking representatives available

Questions, problèmes ou pièces manquantes?

Avant de retourner le produit à votre détaillant, communiquer avec le service à la clientèle au

1-866-839-2888

du lundi au vendredi de 8 h à 17 h HE
(Canada et États-Unis)

Langues ; anglais et français

Preguntas, problemas, piezas faltantes?

Antes de volver a la tienda, llame a nuestro departamento de servicio al cliente al

1-866-839-2888

8 am. - 5 pm., HDE, Lunes a Viernes
(Canadá y Estados Unidos solamente)

Representantes disponibles para inglés y francés



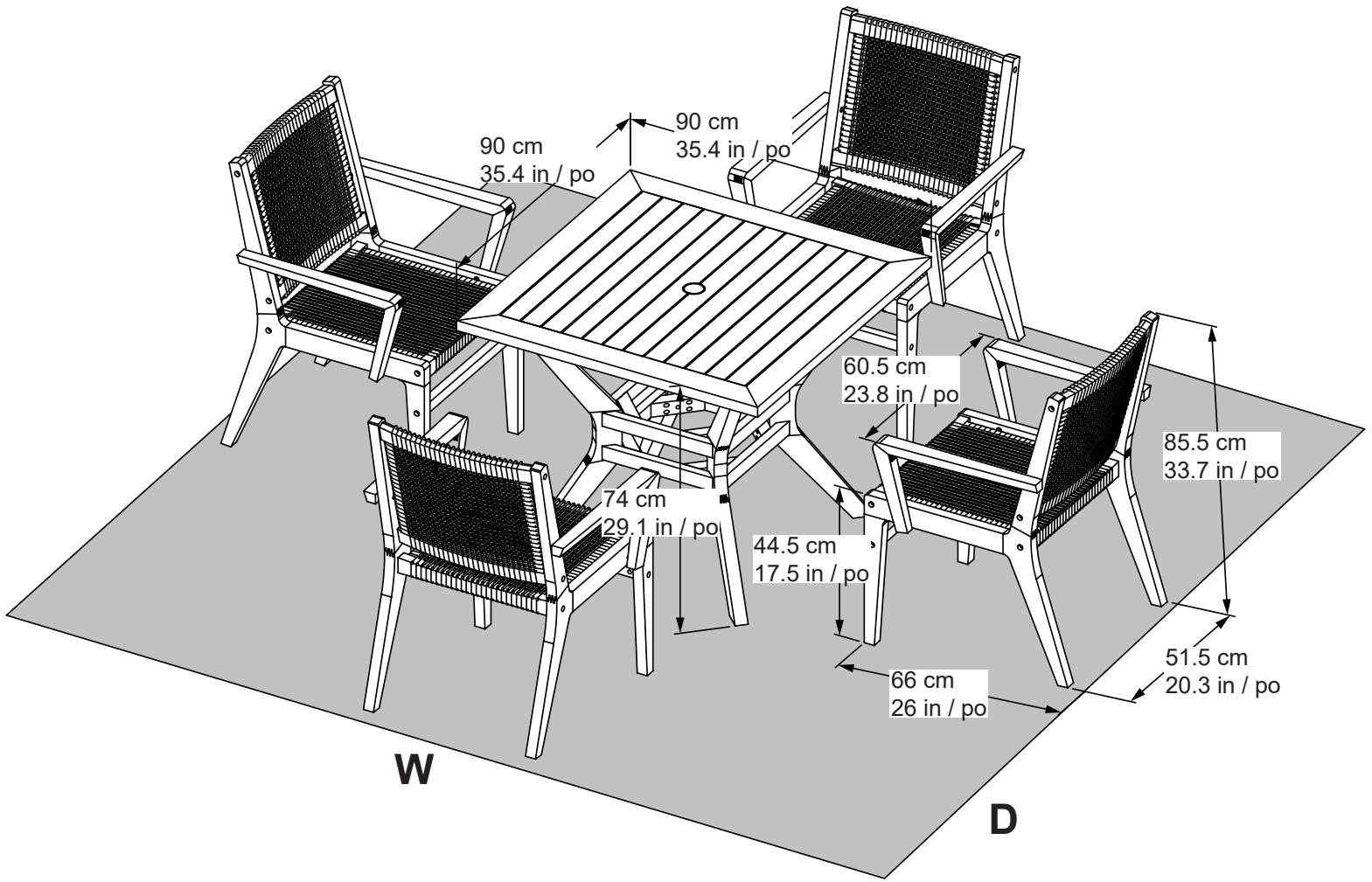







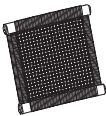

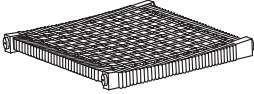
**MINIMUM FLOOR SPACE
SURFACE MINIMALE
SUPERFICIE MÍNIMA**

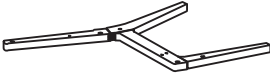
W: 3.44 m / 11.3 ft / pi

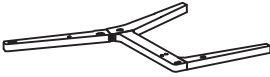
D: 3.44 m / 11.3 ft / pi

	Item / Pièce / Ítem	QTY QTÉ CTD		Item / Pièce / Ítem	QTY QTÉ CTD		Item / Pièce / Ítem	QTY QTÉ CTD
A		1	D1		1	G		8
B		1	D2		1	H		10
C1		1	E		1	I		2
C2		1	F		8	J		1

ASSEMBLY / ASSEMBLAGE / ENSAMBLE







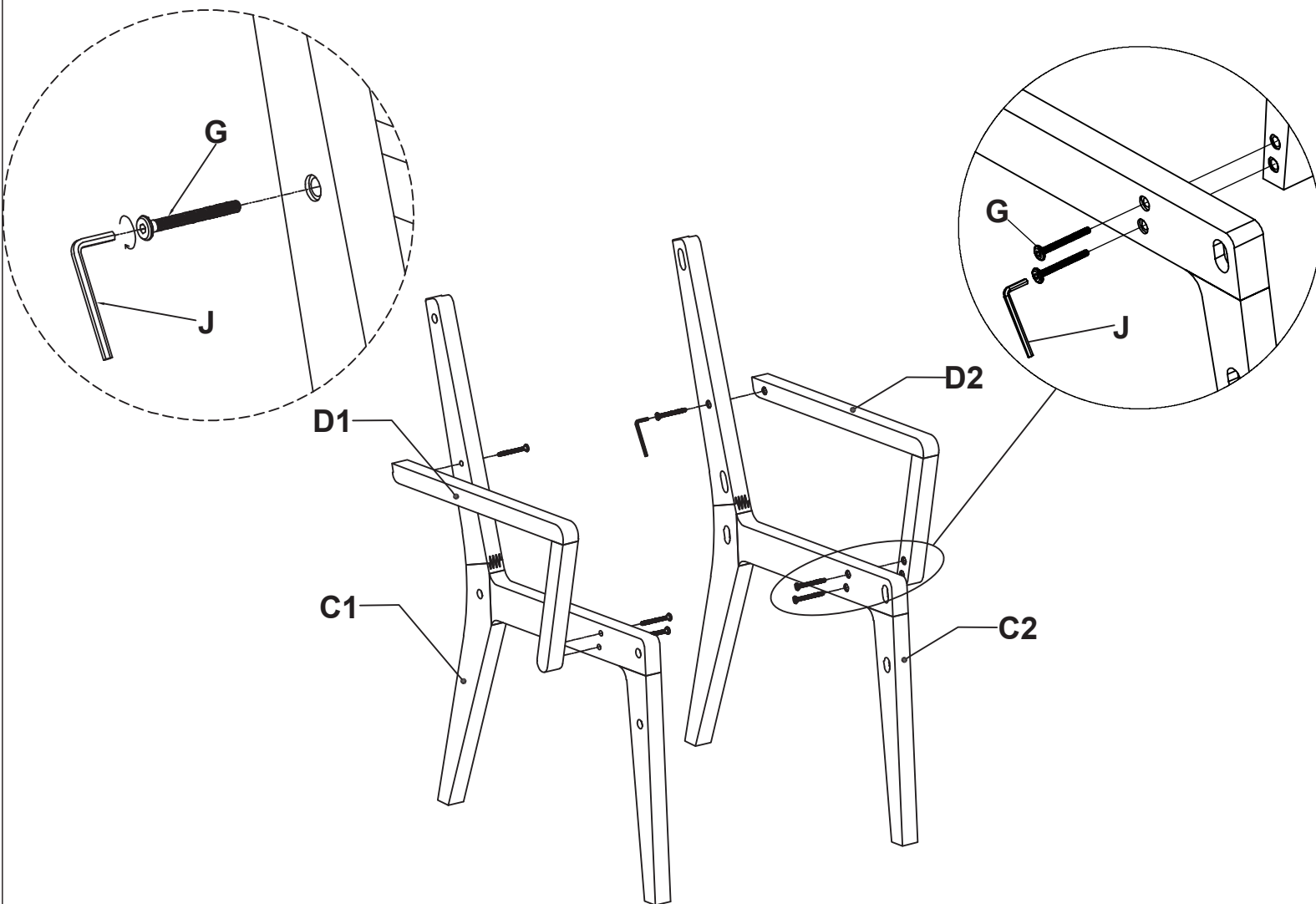

1

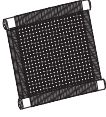
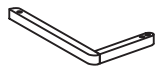
For easier assembly and to avoid product damages, tighten all screws only once the item is fully assembled.

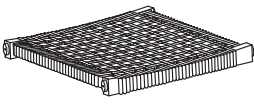
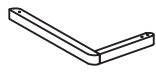
Pour un assemblage facile et pour éviter d'endommager le produit, ne serrer les vis qu'une fois le produit complètement assemblé.

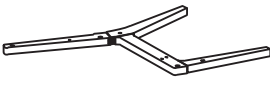
Para facilitar el montaje y evitar daños al producto, apriete todos los tornillos una vez el producto este completamente ensamblado.

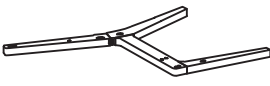

	Item / Pièce / Ítem	QTY QTÉ CTD		Item / Pièce / Ítem	QTY QTÉ CTD		Item / Pièce / Ítem	QTY QTÉ CTD
A		1	D1		1	G		8
B		1	D2		1	H		10
C1		1	E		1	I		2
C2		1	F		8	J		1





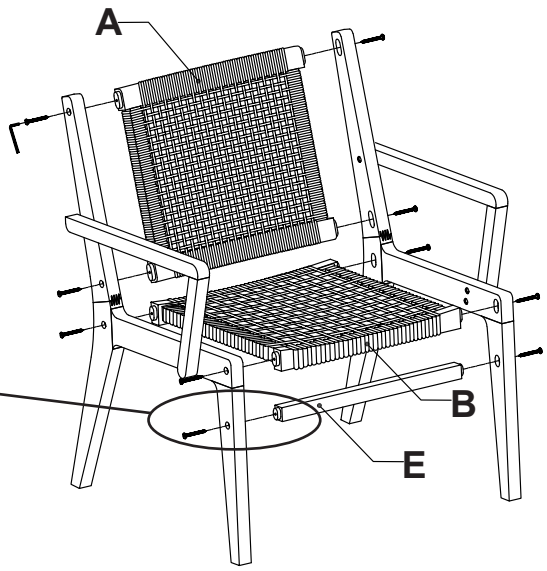
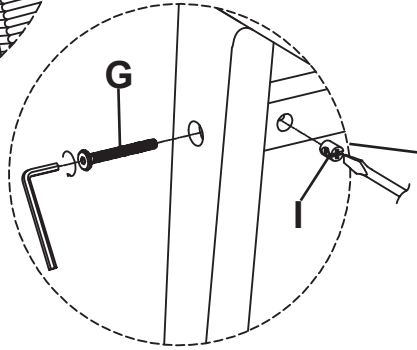
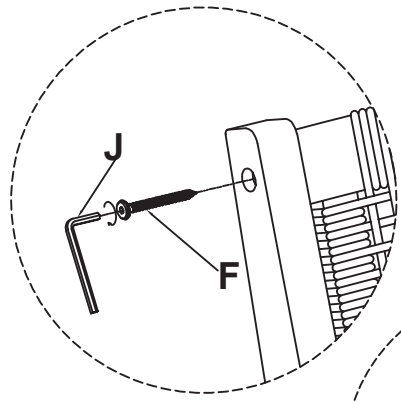

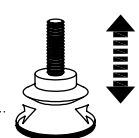
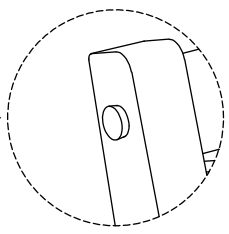
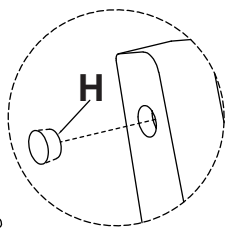
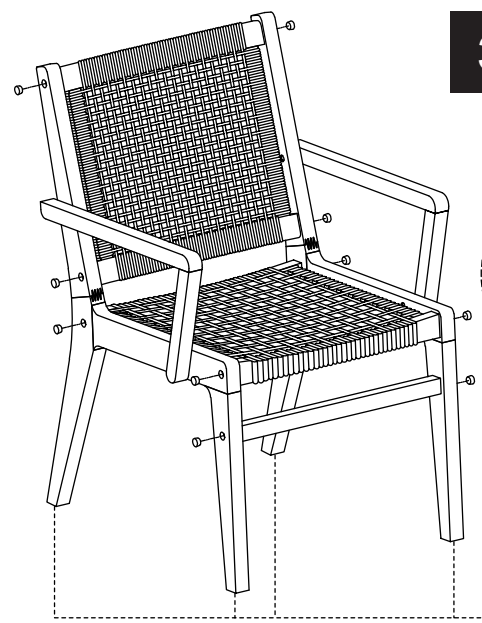

ASSEMBLY / ASSEMBLAGE / ENSEMBLE

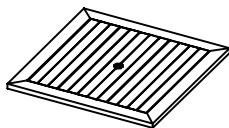
2

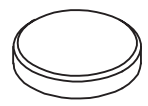

3



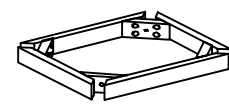





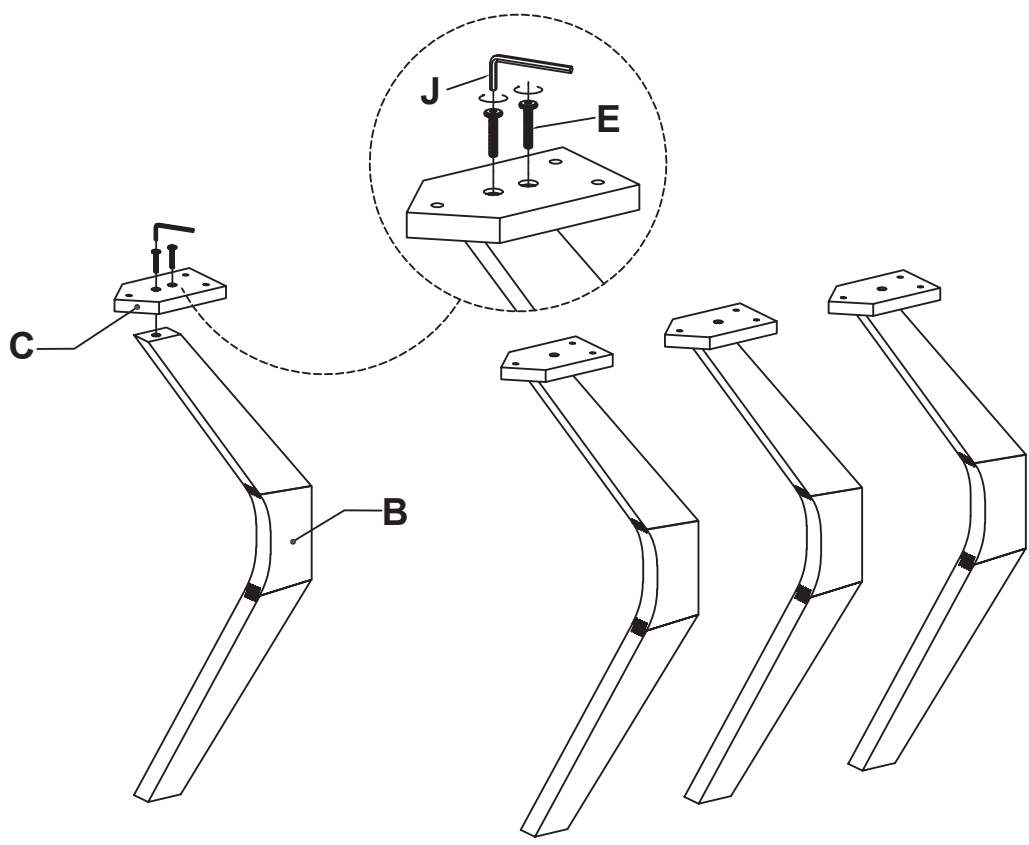

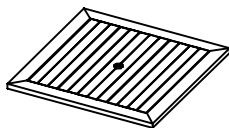
	Item / Pièce / Ítem	QTY QTÉ CTD		Item / Pièce / Ítem	QTY QTÉ CTD		Item / Pièce / Ítem	QTY QTÉ CTD
A		1	E	 M6x30	20	H		8
B		4	F	 M6x50	8	I		1
C		4	G		8	J		1
D		2						

ASSEMBLY / ASSEMBLAGE / ENSEMBLE

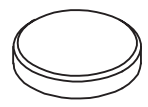
1



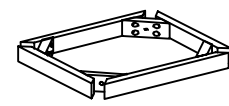





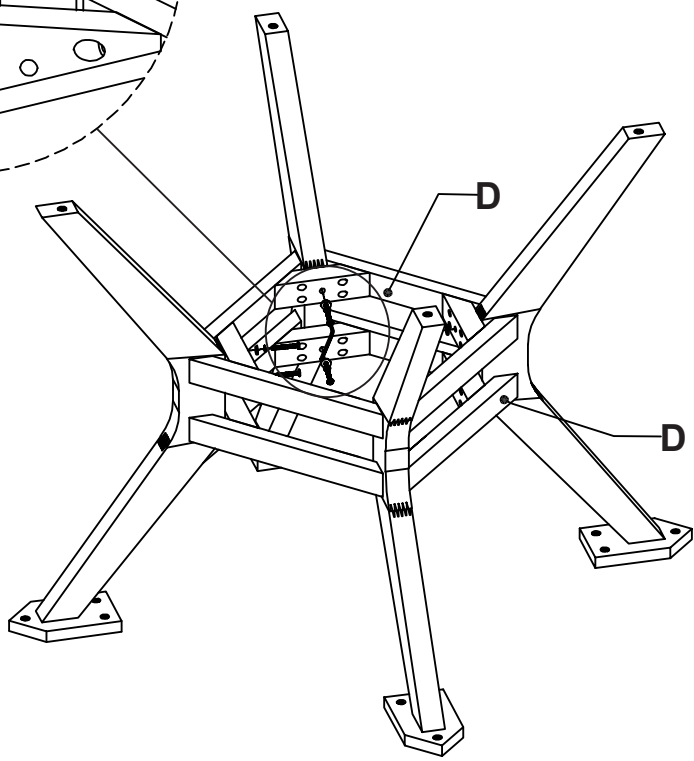
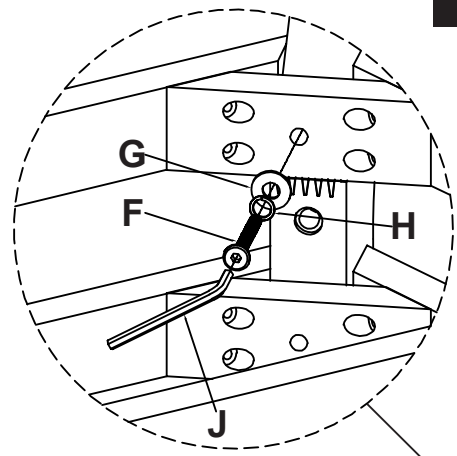

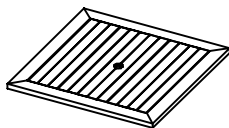
	Item / Pièce / Ítem	QTY QTÉ CTD		Item / Pièce / Ítem	QTY QTÉ CTD		Item / Pièce / Ítem	QTY QTÉ CTD
A		1	E	 M6x30	20	H		8
B		4	F	 M6x50	8	I		1
C		4	G		8	J		1
D		2						

ASSEMBLY / ASSEMBLAGE / ENSEMBLE

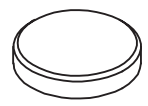
2



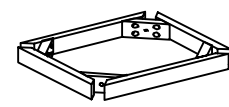





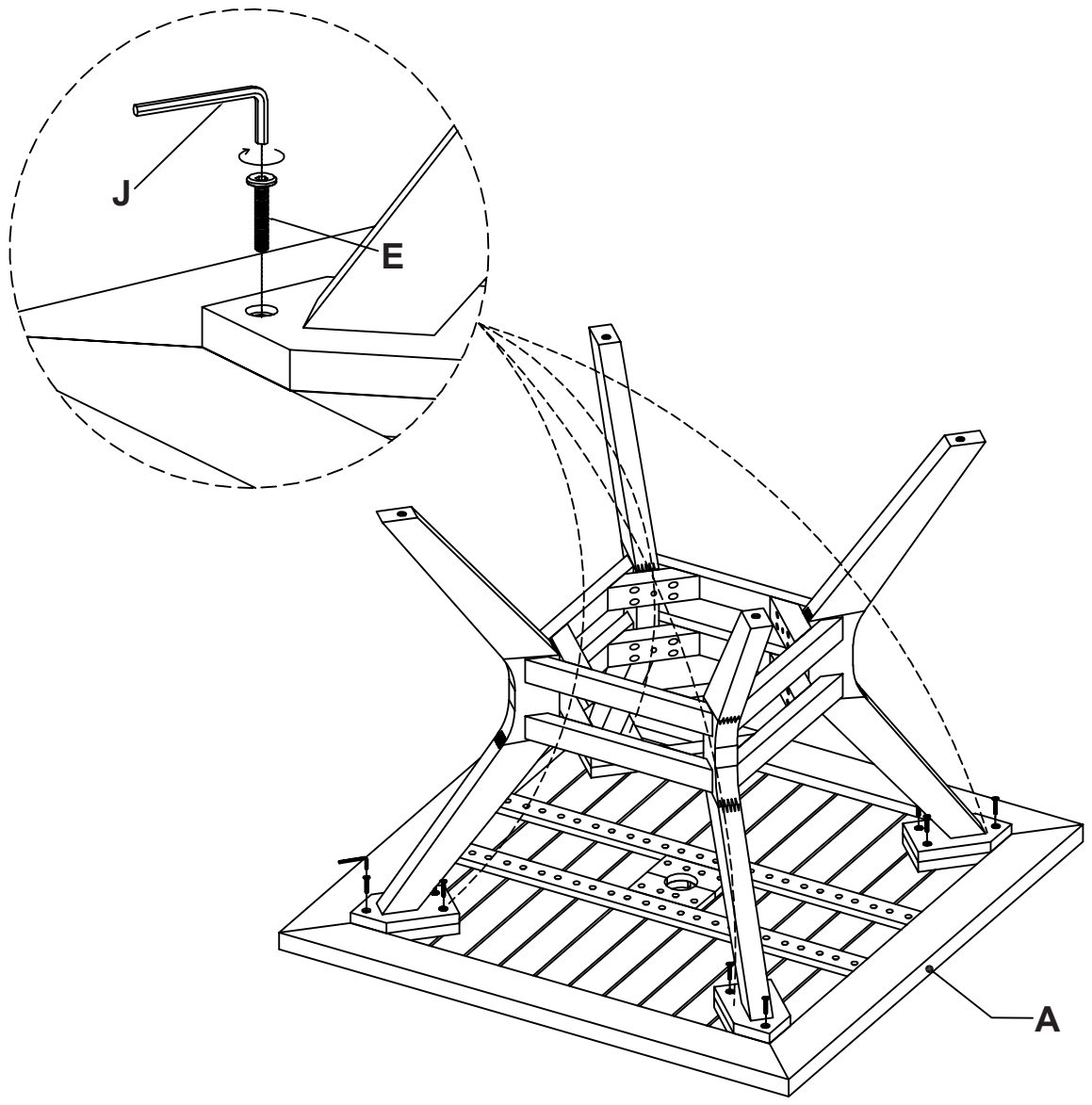

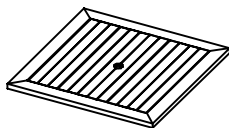
	Item / Pièce / Ítem	QTY QTÉ CTD		Item / Pièce / Ítem	QTY QTÉ CTD		Item / Pièce / Ítem	QTY QTÉ CTD
A		1	E	 M6×30	20	H		8
B		4	F	 M6×50	8	I		1
C		4	G		8	J		1
D		2						

ASSEMBLY / ASSEMBLAGE / ENSEMBLE

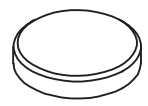
3

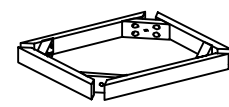

	Item / Pièce / Ítem	QTY QTÉ CTD		Item / Pièce / Ítem	QTY QTÉ CTD		Item / Pièce / Ítem	QTY QTÉ CTD
A		1	E	 M6×30	20	H		8
B		4	F	 M6×50	8	I		1
C		4	G		8	J		1
D		2						

ASSEMBLY / ASSEMBLAGE / ENSEMBLE

4

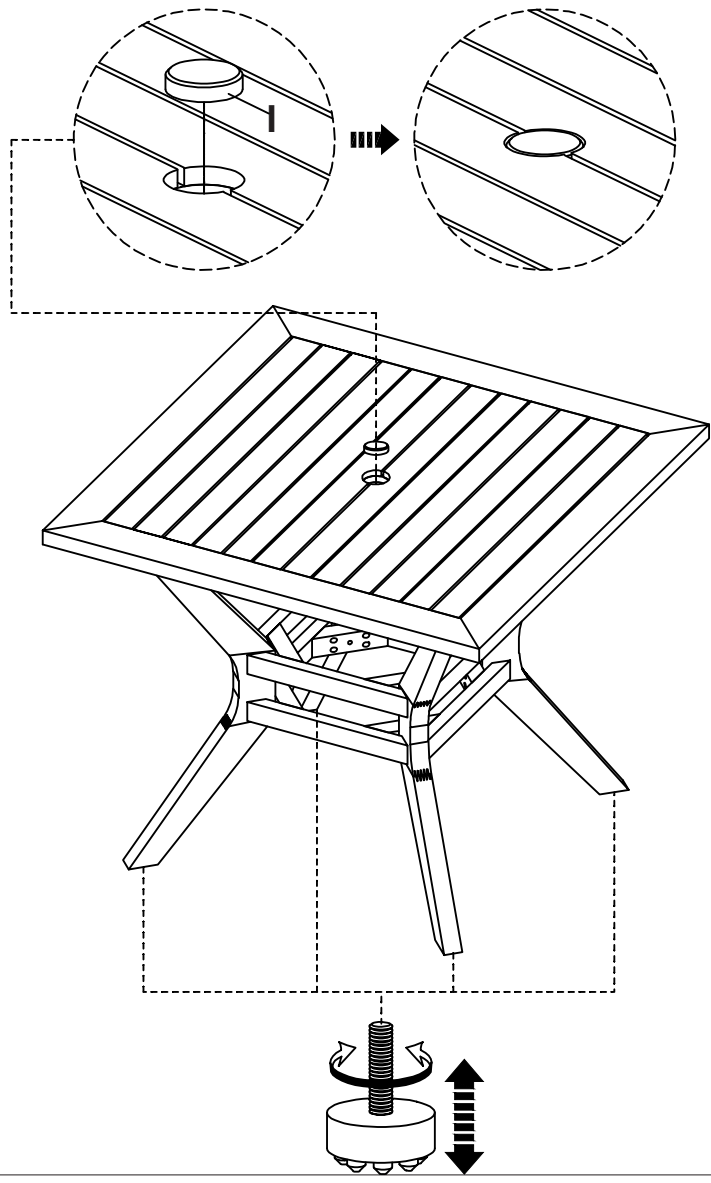

FOR DOMESTIC USE ONLY.

MAINTENANCE - Store in a dry area out of the elements, or cover with furniture covers when not in use.

TABLETOP: CLEANING - Use mild soap and water. Do not use abrasive materials or cleansers.

WICKER: CLEANING - UV protected synthetic wicker allows color retention after hours of outdoor use. Hose off outdoors for easy cleaning. Wipe up minor spills with a mild soap and damp cloth.

POUR USAGE DOMESTIQUE SEULEMENT.

ENTRETIEN - Entreposer dans un endroit sec à l'abri des éléments ou couvrir à l'aide d'une housse lorsque le produit n'est pas utilisé.

DESSUS DE TABLES: NETTOYAGE - Utiliser de l'eau et un savon doux. Ne pas utiliser de matériaux abrasifs.

OSIER: NETTOYAGE - La protection UV de l'osier synthétique lui permet de garder sa couleur après des heures d'usage extérieur.

SÓLO PARA USO DOMÉSTICO.

MANTENIMIENTO - Guarde en un lugar seco alejado de la intemperie, o cúbralo con fundas protectoras para muebles cuando no está en uso.

MESA: LIMPIEZA - Utilice un jabón suave y agua. No utilice materiales ni limpiadores abrasivos.

MIMBRE: LIMPIEZA - La protección UV del mimbre sintético le permite conservar su color después de muchas horas de uso al exterior. Lávelo al exterior con una manguera para facilitar la limpieza. Utilice un jabón suave y un paño húmedo.

Distributed by:
Costco Wholesale Corporation
P.O. Box 34535
Seattle, WA 98124-1535
USA
1-800-774-2678
www.costco.com

Costco Wholesale Canada Ltd.*
415 W. Hunt Club Road
Ottawa, Ontario
K2E 1C5, Canada
1-800-463-3783
www.costco.ca
* faisant affaire au Québec sous
le nom les Entrepôts Costco

Importado por:
Importadora Primex S.A. de C.V.
Blvd. Magnocentro No. 4
San Fernando La Herradura
Huixquilucan, Estado de México
C.P. 52765
RFC: IPR-930907-S70
(55)-5246-5500
www.costco.com.mx

Costco Wholesale UK Ltd /
Costco Online UK Ltd
Hartspring Lane
Watford, Herts
WD25 8JS
United Kingdom
01923 213113
www.costco.co.uk

Costco Wholesale Spain S.L.U.
Polígono Empresarial Los Gavilanes
C/ Agustín de Betancourt, 17
28906 Getafe (Madrid) España
NIF: B86509460
900 111 155
www.costco.es

Costco Wholesale Australia Pty Ltd
17-21 Parramatta Road
Lidcombe NSW 2141
Australia
www.costco.com.au

Costco Wholesale Korea, Ltd.
40, Iljik-ro
Gwangmyeong-si
Gyeonggi-do, 14347, Korea
1899-9900
www.costco.co.kr

Costco Wholesale Japan Ltd.
3-1-4 Ikegami-Shincho
Kawasaki-ku, Kawasaki-shi,
Kanagawa 210-0832 Japan
0570-200-800
www.costco.co.jp

Costco Wholesale New Zealand Limited
2 Gunton Drive
Westgate
Auckland 0814
New Zealand

Costco France
1 avenue de Bréhat
91140 Villebon-sur-Yvette
France
01 80 45 01 10
www.costco.fr

Costco Wholesale Iceland ehf.
Kauptún 3-7, 210 Gardabaer
Iceland
www.costco.is

Costco (China) Investment Co., Ltd.
Room 1003, Block 2, 2388 Xiupu Road,
Pudong New Area, Shanghai
China 201315
+86-21-6257-7065